



## Biard 2m Track - White



### Product Specification

Connection Type **Single Circuit**

Dimensions **2000 x 35 x 17mm**

Waterproof **No**

Input Power **200-240VAC**

Certification **CE, RoHS, LVD**

Input Frequency **50Hz**

Weight **0.4kg**

### Product Specification

- ✓ Single Circuit
- ✓ White
- ✓ Strong Aluminium Constriction
- ✓ Non-Recessed
- ✓ 3 Year Warranty

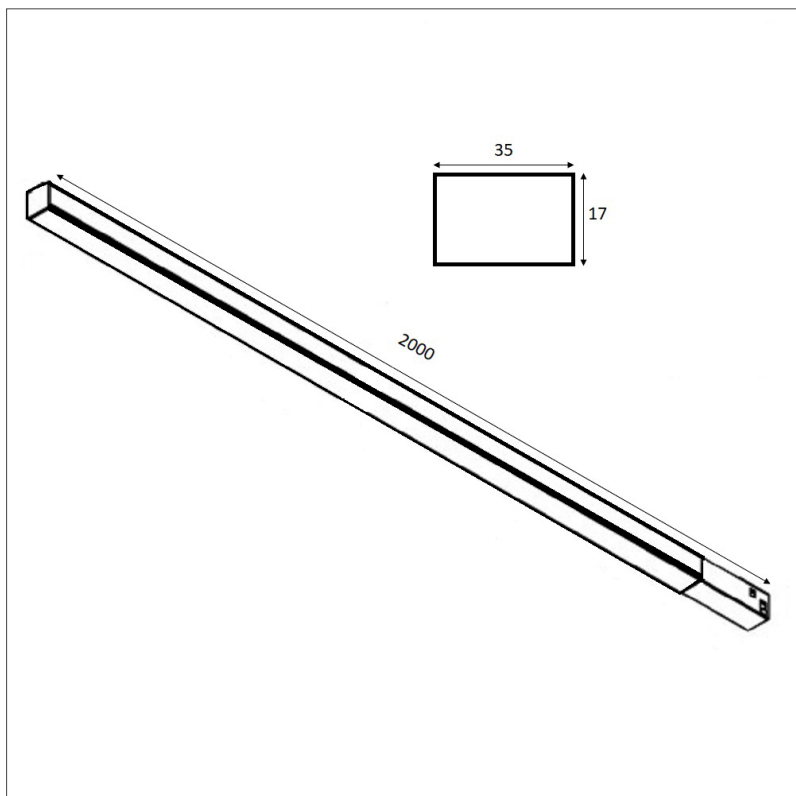

### ⚠ Safety Information

- ✓ Use only stated voltages.
- ✗ **DO NOT** look directly into LED.
- ✗ **DO NOT** spray with chemicals.
- ✓ If in doubt use a qualified electrician.
- ✗ **NEVER** expose electrical parts when switched on.
- ✗ **DO NOT** remove PIR (if fitted).
- ✗ **DO NOT** cover with flammable materials.
- ✓ Turn off power before fitting.

This product is covered by a 3 year warranty and has a 30 day money back guarantee.

