

Milano

Freestanding Bath shower mixer

Installation Guide

Contents

Safety Information **Page - 2**

Installation **Page - 2**

Warranty Information **Page - 6**

Recycling & Disposal **Page - 6**

Safety Information

Please read carefully...

- ✓ Check the product for defects before installing.
- ✓ We recommend installation is performed by a qualified plumber.
- ✓ We recommend a minimum operating pressure of 2 bar.
- ✓ DO NOT lean on this product or rest heavy objects against it.
- ✓ Please Note: This product is designed to have base union fitted into a solid floor, it is not possible to surface mount this tap.

Installation

Parts needed:

1. Adjustable spanner
2. Hex Keys (provided)

1

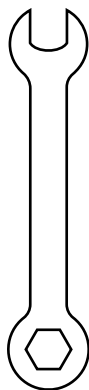

2

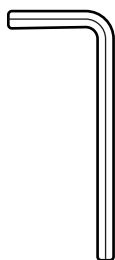

1

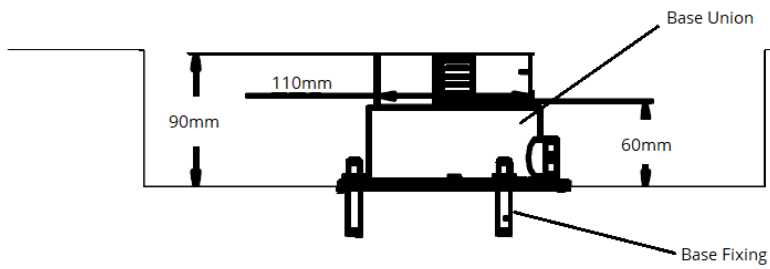

Mark out, Drill and mount the base union into the floor using suitable fixings.

Ensure that the base union is level and horizontal, the base union has a gradienter built into the top to aid with levelling it.

2

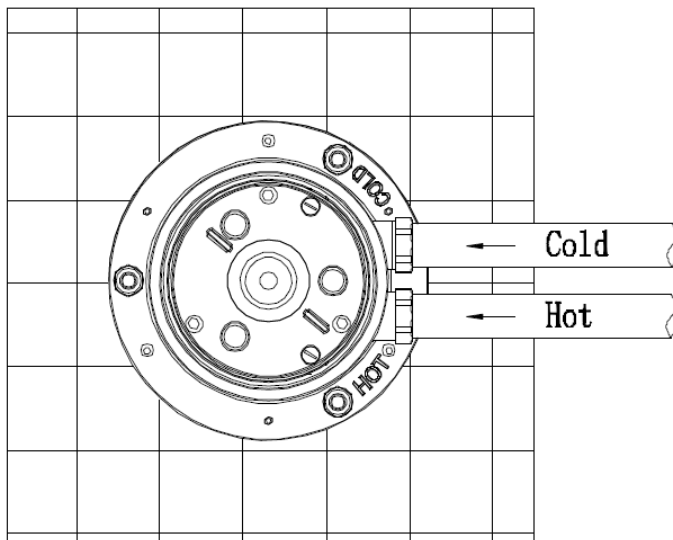

Connect the HOT/COLD feed to the appropriate connection. It is recommended that you check the connections for leaks before continuing with installation.

*When you complete this point please place the protective cover over the base union.

Floor

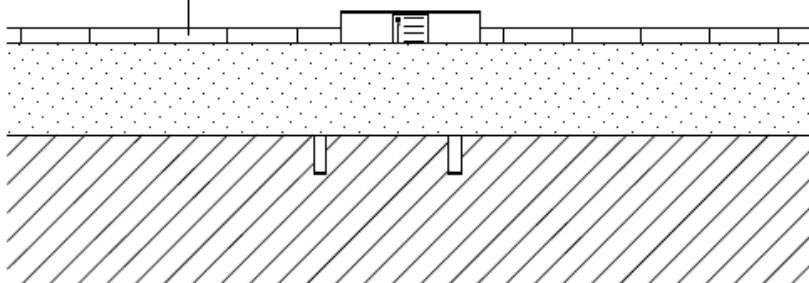

If flooring after installing the product, fit the flooring up to the protective cover.

Once this is done, cut off the protective cover so it is level with the floor.

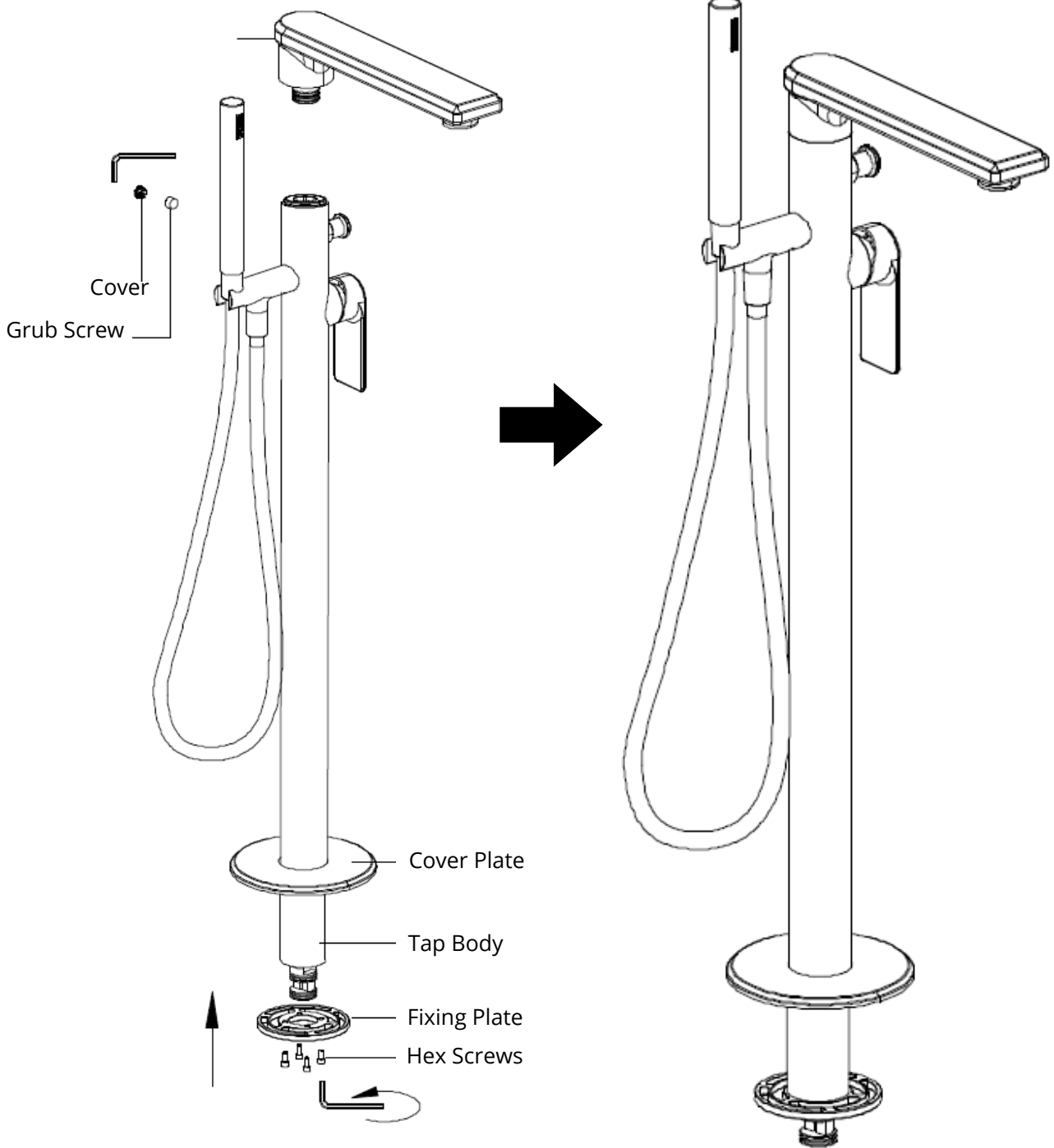

Place the cover plate onto the tap body and mount the fixing plate onto the end of the tap body and secure in place with the Hex head screws.

Fix the spout onto the tap body and lock in place using a Hex key.

Style may vary

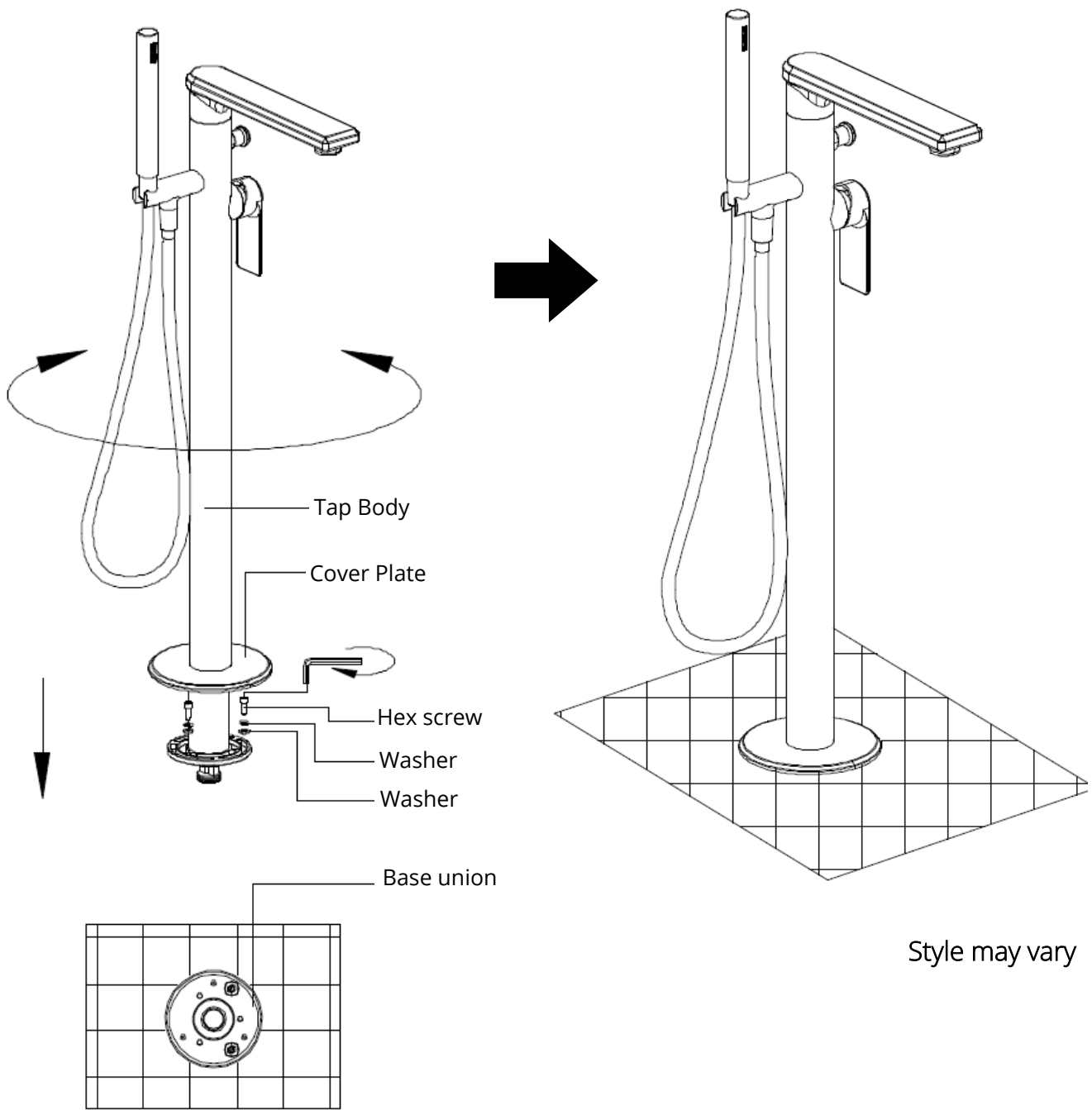

Mount the tap body onto the base union and secure in place with the hex screws and washers ,
Finally slide the cover plate onto the floor to cover the base union. The product is now ready for use.

Aftercare

Clean any marks with a soft dry cloth, for stubborn stains please clean with mild soapy water and buff out with a soft cloth. DO NOT use abrasive or acidic cleaners, if you are unsure, please contact us first.

Your Guarantee

- To find the specific guarantee for your product please refer to the website.
- The guarantee starts from the date of purchase.
- The guarantee covers you against issues caused as a result of manufacturing related issues, it does not apply to issues that are found to be a result of poor installation.
- Labour costs for installation of the product are not covered under this warranty.

Recycling and Disposal

Please recycle the packaging in accordance with your local government regulations on waste handling, and follow the same advice at the end of the products life.

Product - Steel.

Packaging - Cardboard, plastic, steel.

Contact us

Milano

Unit 1 & 2 Dawson Ct

Burnley

Lancashire

BB11 5UB