

biard

BLSS9

Installation Guide

Contents

Safety Information **Page - 2**

Installation **Page - 3 - 4**

Warranty Information **Page - 4**

Recycling & Disposal **Page - 4**

Safety Information

Please read carefully...

- ✓ Check the product for defects before installing.
- ✗ **DO NOT** install the product within 0.2 metres of flammable materials.
- ✓ Ensure any cables/wires supplied with the product are in good condition.
- ✓ Only use products supplied to install.
- ✗ Avoid looking directly into the light when switched on.
- ✗ There are no user serviceable parts inside this product. **DO NOT** disassemble or attempt to repair.
- ✓ Read all the instructions in the manual before beginning installation if in doubt use a qualified electrician.
- ✓ This product is rated IP44 and is suitable for indoor or outdoor use.

Installation

Tools required for installing:

1. Flat and Cross screwdrivers
2. Drill and drill bit (8mm)
3. Pencil

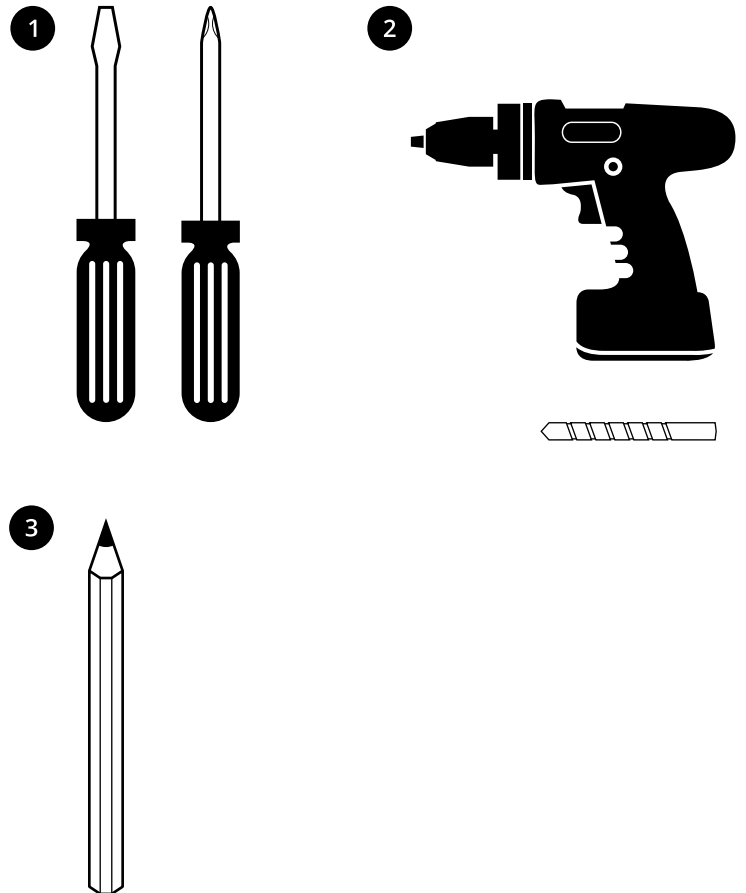

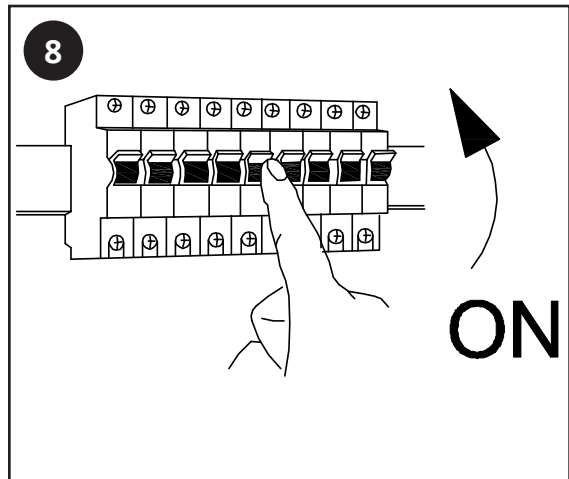
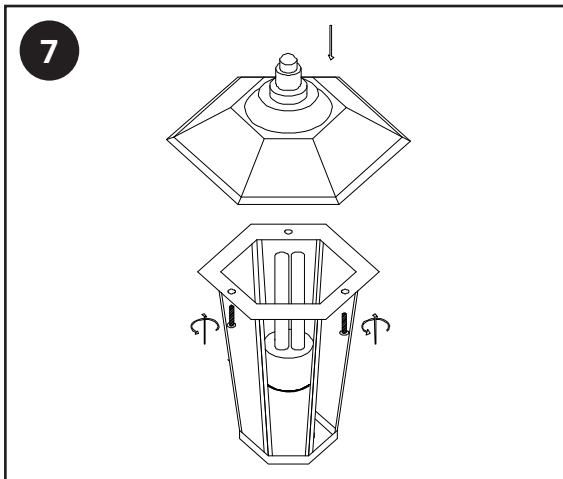
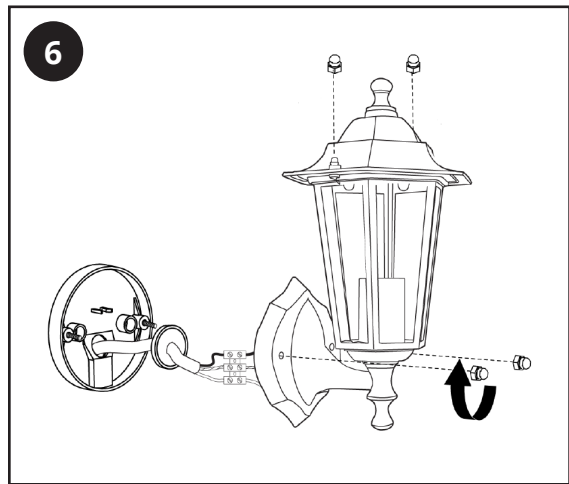
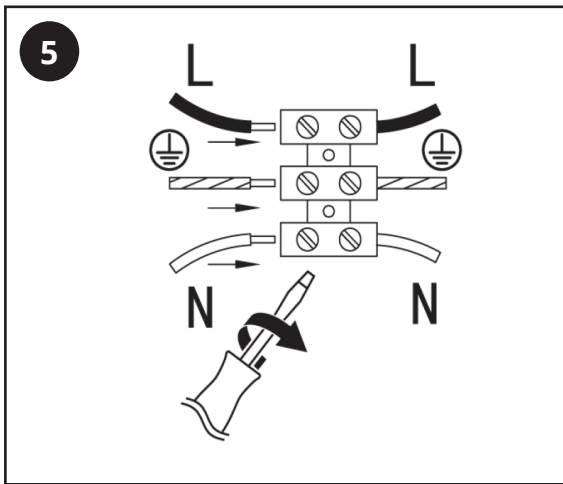
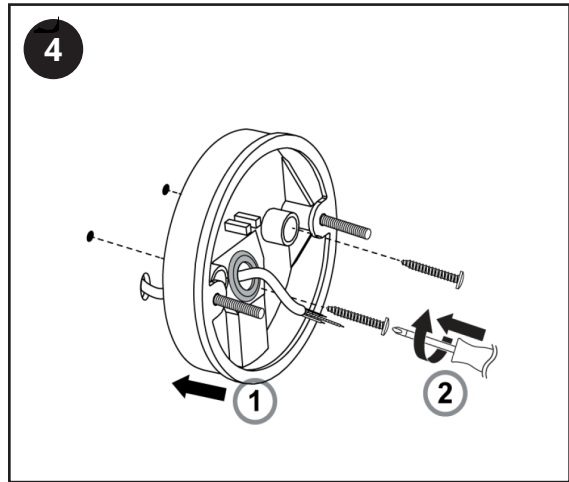
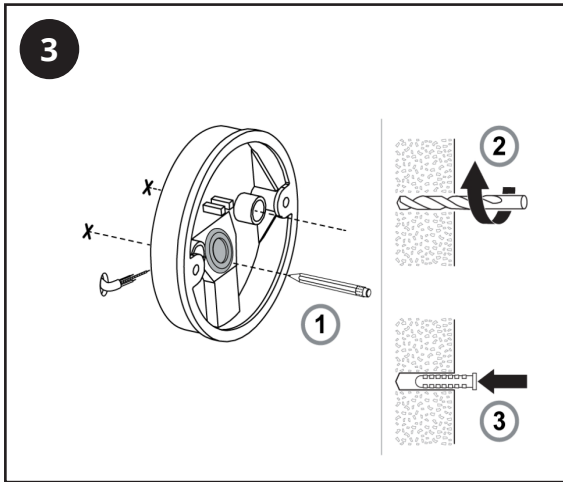
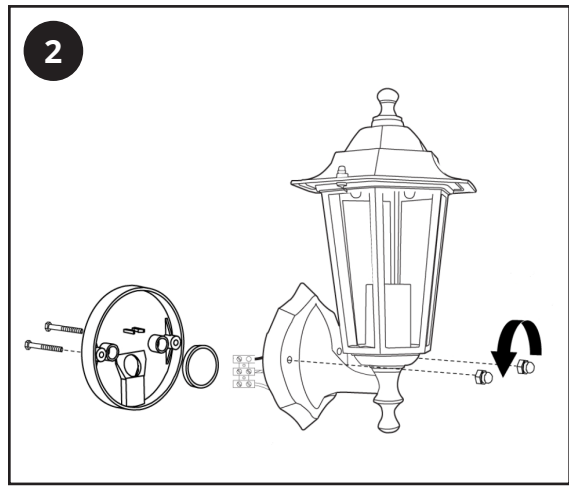
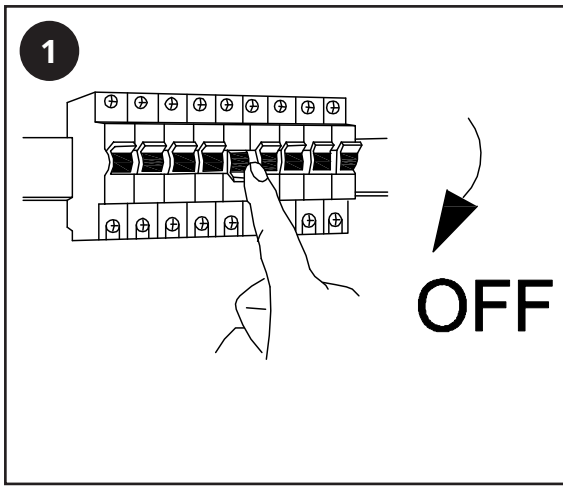

Warranty Information

- *This product is covered by the standard Biard 3 limited year warranty for any manufacturing faults.*
- *The warranty starts from the date of purchase.*
- *Labour costs for installation of the Product are not covered under this warranty.*
- *The warranty is only valid when products are properly installed and operated as specified in this manual and the data sheets.*
- *All warranty queries should be through the stockist that the product was purchased through.*

Recycling & Disposal

The Waste Electrical and Electronic Equipment Directive (WEEE Directive) is the **European Community directive** 2012/19/EU on **Waste Electrical and Electronic Equipment (WEEE)** which, together with the **RoHS Directive** 2002/95/EC, became European Law in February 2003

The **WEEE** directive aims to reduce the amount of electrical equipment being produced and to encourage everyone to reuse, recycle and recover it.

In support of these guidelines and for environmental safety, do not dispose of any electrical equipment including those marked with the below symbols

When replacing old electrical devices with new ones the retailer is legally obligated to take back your old items for disposal free of charge. You can also recycle your old electrical devices free of charge at your local recycling centre. Please contact your local council for more information.



Manufacturer



Consult
Instructions
For Use

REF

Catalogue
Number