

Milano

BLMIRROR3

Installation Guide

Contents

Installation **Page - 2**

Safety Information **Page - 2**

Warranty Information **Page - 4**

Recycling & Disposal **Page - 4**

Safety Information

Please read carefully...

- ✓ Check the product for defects before installing.
- ✓ Ensure any cables/wires supplied with the product are in good condition.
- ✓ Only use products supplied to install.
- ✓ This Product contains glass, please handle carefully.
- ✓ There are no user serviceable parts inside this product. **DO NOT** disassemble or attempt to repair.
- ✓ Read all the instructions in the manual before beginning installation, if in doubt use a qualified electrician.
- ✓ **IP44** - This product is suitable for indoor only.
- ✓ This product should be installed by a qualified Electrician.

Installation

1

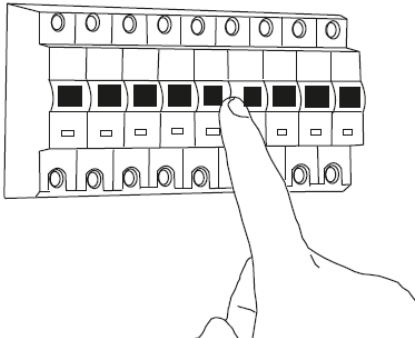

Turn off the power before installing.

OFF!
COUPEZ LE COURANT

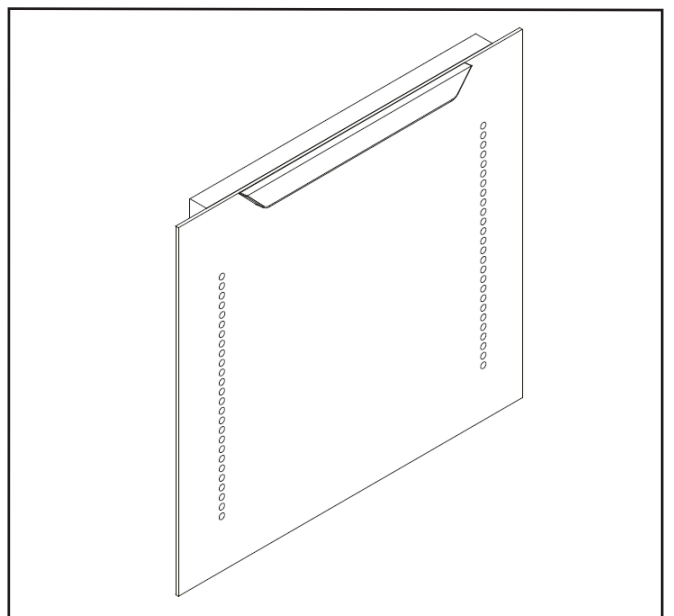
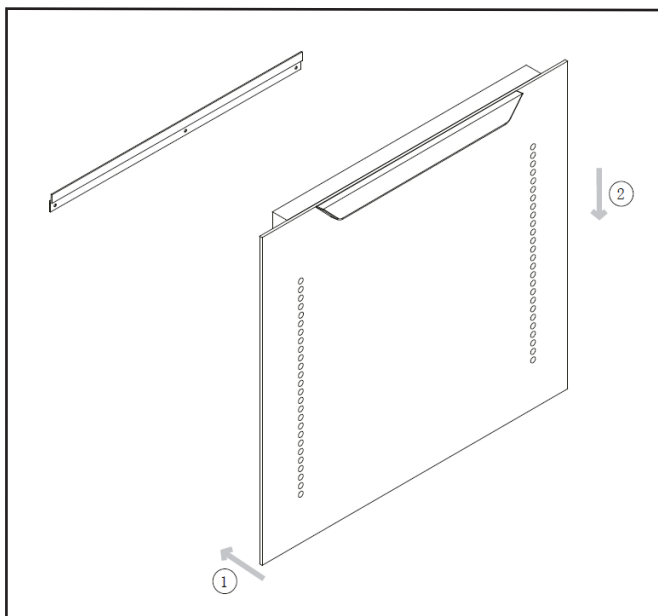
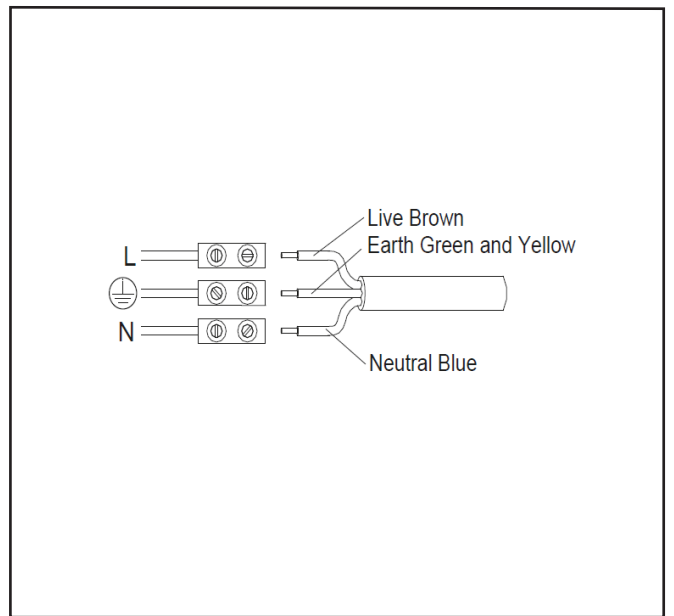
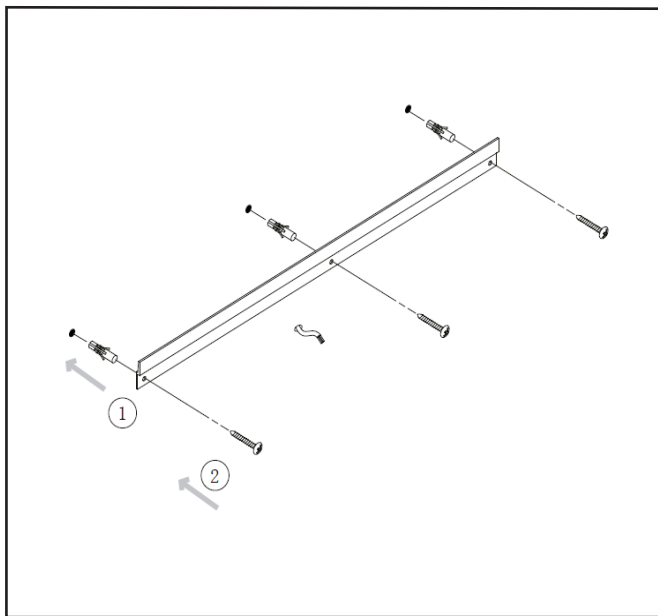

Warranty Information

- *This product is covered by a standard 3 year warranty for any manufacturing faults.*
- *The warranty starts from the date of purchase.*
- *Labour costs for installation of the Product are not covered under this warranty.*
- *The warranty is only valid when products are properly installed and operated as specified in this manual and the data sheets.*
- *All warranty queries should be through the stockist that the product was purchased through.*

Recycling & Disposal

The Waste Electrical and Electronic Equipment Directive (WEEE Directive) is the **European Community directive** 2012/19/EU on **Waste Electrical and Electronic Equipment (WEEE)** which, together with the **RoHS Directive** 2002/95/EC, became European Law in February 2003

The **WEEE** directive aims to reduce the amount of electrical equipment being produced and to encourage everyone to reuse, recycle and recover it.

In support of these guidelines and for environmental safety, do not dispose of any electrical equipment including those marked with the below symbols

When replacing old electrical devices with new ones the retailer is legally obligated to take back your old items for disposal free of charge. You can also recycle your old electrical devices free of charge at your local recycling centre. Please contact your local council for more information.



Contact Us

MILANO
Unit 1 & 2
Dawson Ct
Burnley
BB11 5UB